

Features

- 0.25 INCH DIGIT HEIGHT
- LOW CURRENT OPERATION.
- EXCELLENT CHARACTER APPEARANCE.
- EASY MOUNTING ON P.C. BOARDS OR SOCKETS.
- I.C. COMPATIBLE.
- CATEGORIZED FOR LUMINOUS INTENSITY.
- MECHANICALLY RUGGED.
- STANDARD : GRAY FACE, WHITE SEGMENT.
- RoHS COMPLIANT.

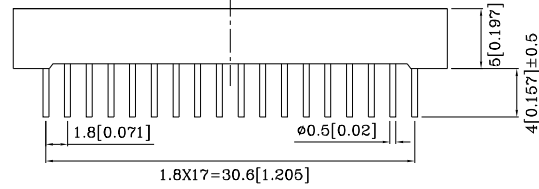
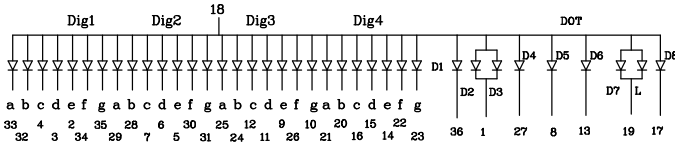
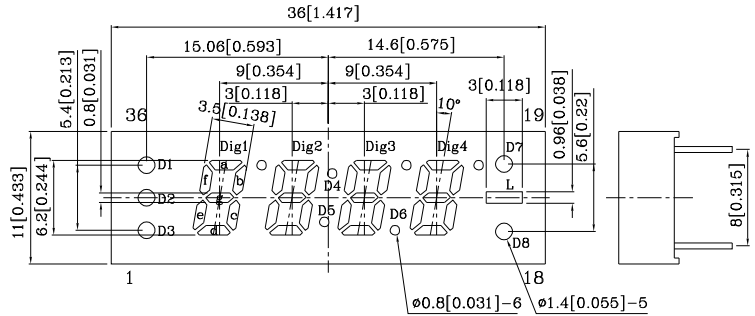

Notes:

1. All dimensions are in millimeters (inches).
2. Tolerance is ± 0.25(0.01") unless otherwise noted.
3. Specifications are subject to change without notice.

Absolute Maximum Ratings (TA=25°C)		MR (GaAlAs)	Unit
Reverse Voltage	Dig1'8,'Dig2'8,'Dig3'8',Dig4'8' D1,D4,D5,D6,D8	VR	5
	D2,D3,D7,L		
Forward Current	Dig1'8,'Dig2'8,'Dig3'8',Dig4'8' D1,D4,D5,D6,D8	IF	30
	D2,D3,D7,L		60
Forward Current (Peak) 1/10 Duty Cycle 0.1ms Pulse Width	Dig1'8,'Dig2'8,'Dig3'8',Dig4'8' D1,D4,D5,D6,D8	iFS	155
	D2,D3,D7,L		310
Power Dissipation	Dig1'8,'Dig2'8,'Dig3'8',Dig4'8' D1,D4,D5,D6,D8	PT	75
	D2,D3,D7,L		150
Operating Temperature	TA	-40 ~ +85	°C
Storage Temperature	Tstg	-40 ~ +85	
Lead Solder Temperature [2mm Below Package Base]		260°C For 3~5 Seconds	

Operating Characteristics (TA=25°C)		MR (GaAlAs)	Unit
Forward Voltage (Typ.) (IF=10mA)	Dig1'8,'Dig2'8,'Dig3'8',Dig4'8' D1,D4,D5,D6,D8	VF	1.8
	D2,D3,D7,L		
Forward Voltage (Max.) (IF=10mA)	Dig1'8,'Dig2'8,'Dig3'8',Dig4'8' D1,D4,D5,D6,D8	VF	2.5
	D2,D3,D7,L		
Reverse Current (Max.) (VR=5V)	Dig1'8,'Dig2'8,'Dig3'8',Dig4'8' D1,D4,D5,D6,D8	IR	10
	D2,D3,D7,L		20
Wavelength of Peak (Typ.) Emission (IF=10mA)		λ P	660
Wavelength of Dominant Emission (Typ.) (IF=10mA)		λ D	640
Spectral Line Full Width (Typ.) At Half-Maximum (IF=10mA)		Δλ	25
Capacitance (Typ.) (VF=0V, f=1MHz)		C	45

Part Number	Emitting Color	Emitting Material	Luminous Intensity (IF=10mA) ucd		Wavelength nm λ P	Description
			min.	typ.		
DMR06A4	Red	GaAlAs	8000	26790	660	Common Anode

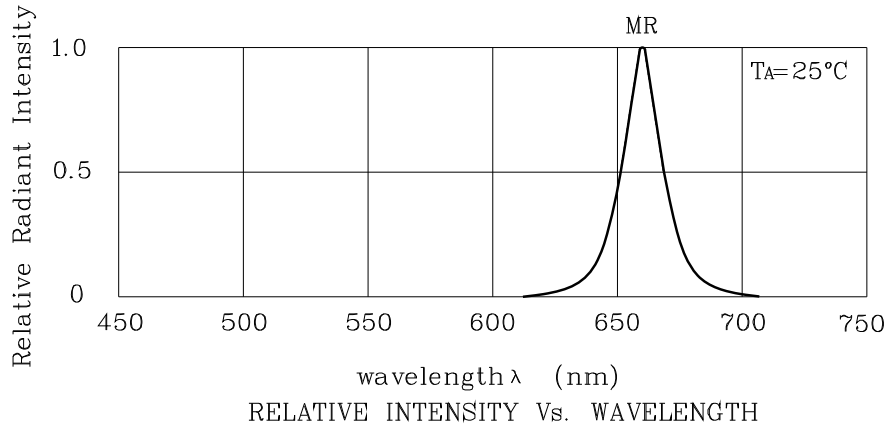

❖ MR

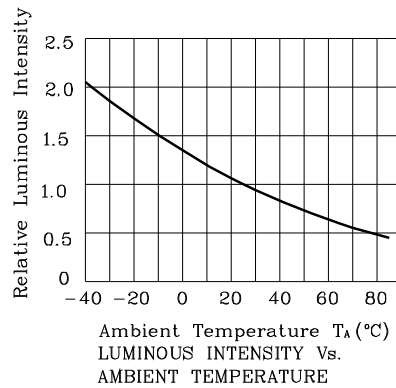
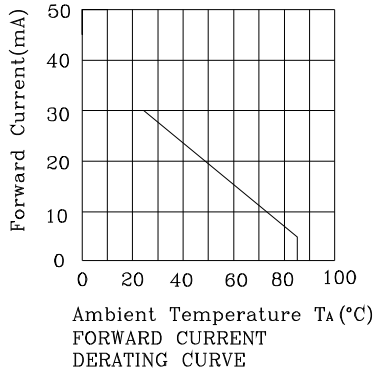
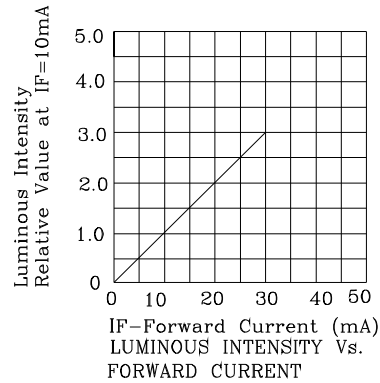
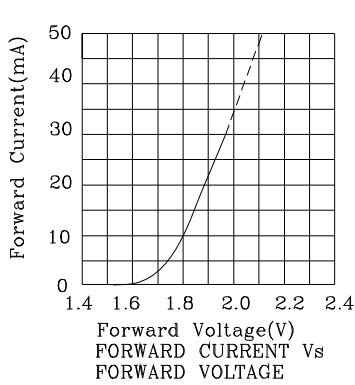



❖ MR

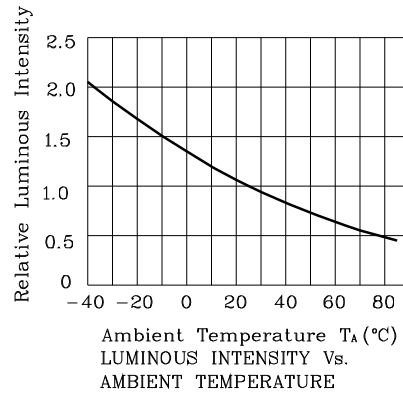
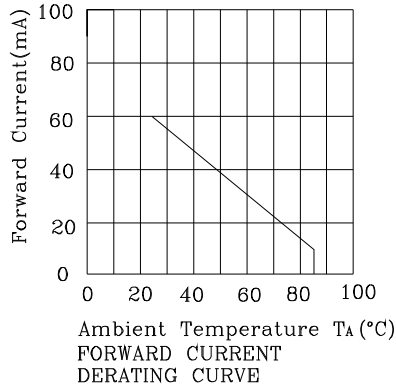
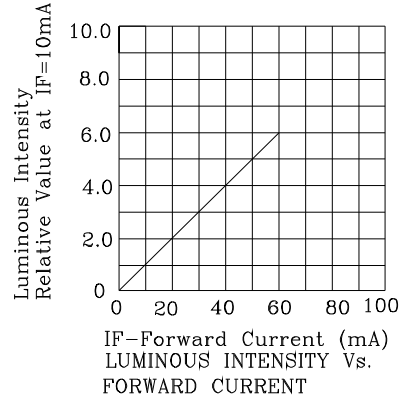
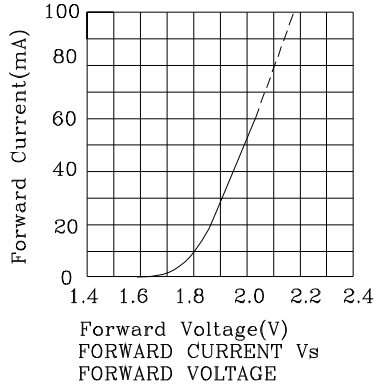

Wave Soldering Profile For Lead-free Through-hole LED.

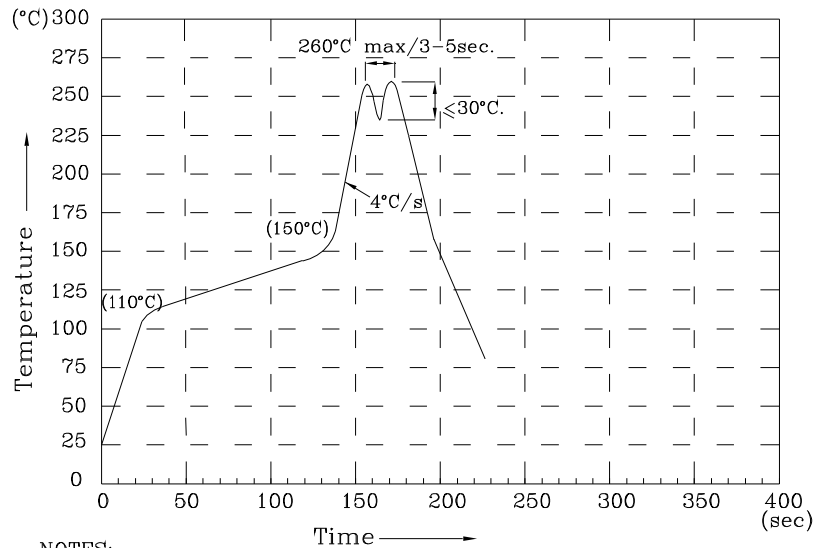

NOTES:

- 1.Recommend the wave temperature 245°C~260°C.The maximum soldering temperature should be less than 260°C.
- 2.Do not apply stress on epoxy resins when temperature is over 85 degree°C.
- 3.The soldering profile apply to the lead free soldering (Sn/Cu/Ag alloy).
- 4.No more than once.

Remarks:

If special sorting is required (e.g. binning based on forward voltage, luminous intensity/ luminous flux or wavelength), the typical accuracy of the sorting process is as follows:

1. Wavelength: +/-1nm
2. Luminous Intensity/ luminous flux: +/-15%
3. Forward Voltage: +/-0.1V

Note: Accuracy may depend on the sorting parameters.

PACKING & LABEL SPECIFICATIONS

DMR06A4

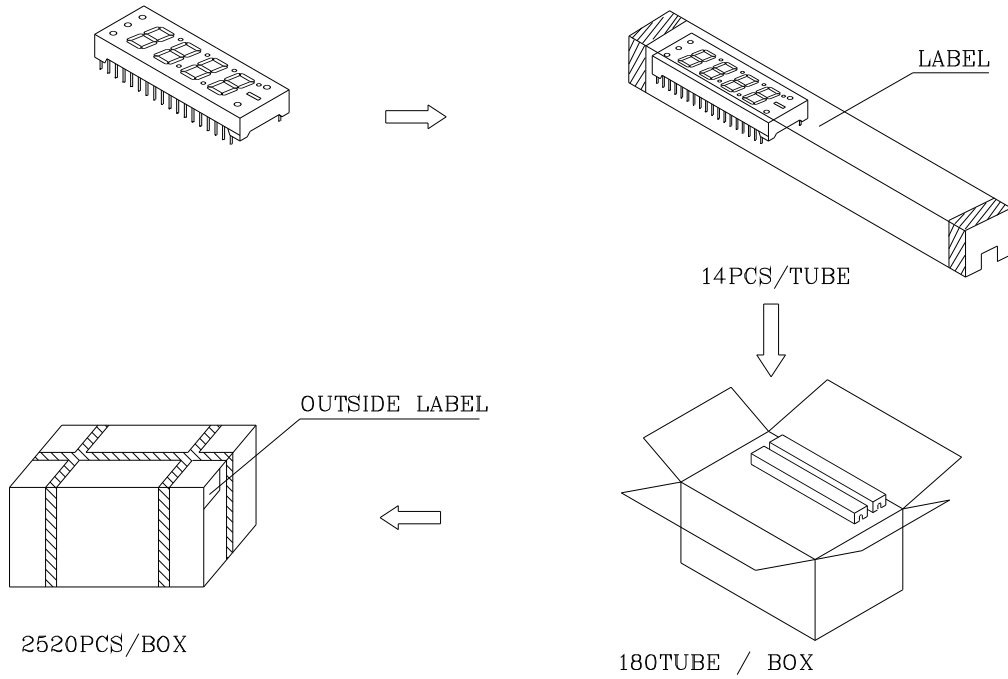

Inside LABEL Paste On The IC-tube

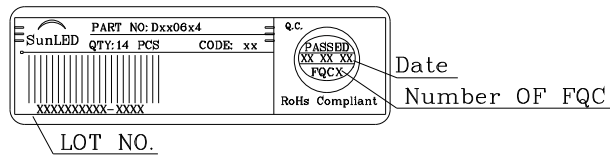

Outside LABEL Paste On The Box

