

❖ MDK

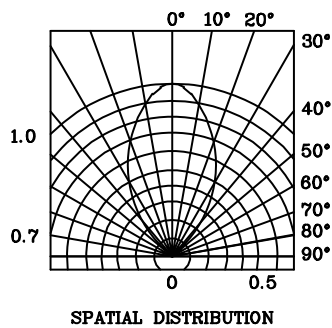

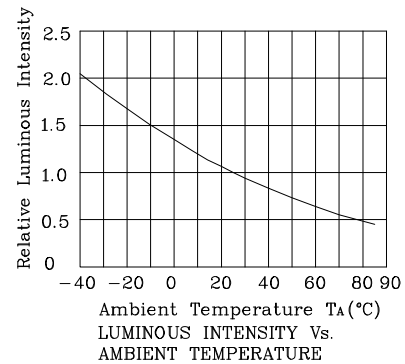

❖ VG

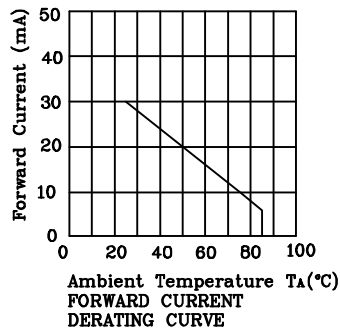
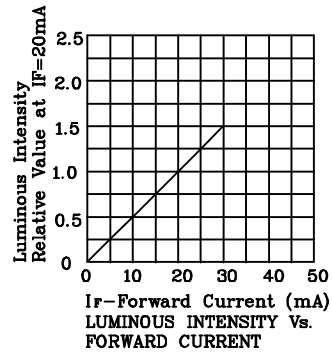
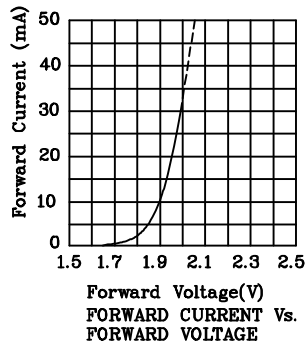
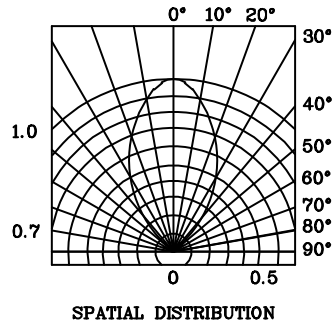
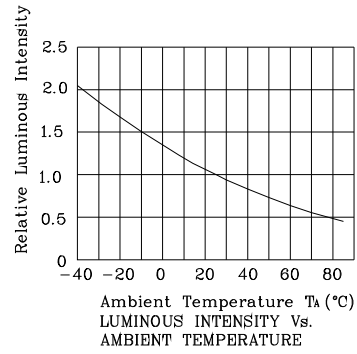
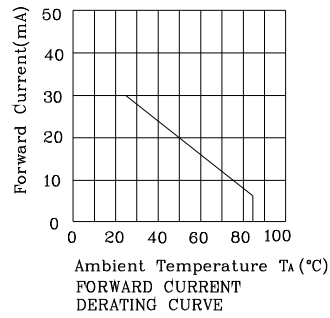
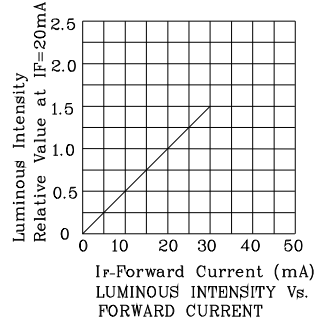
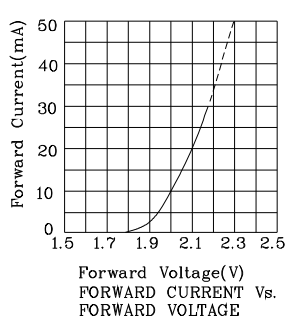

Wave Soldering Profile For Lead-free Through-hole LED.

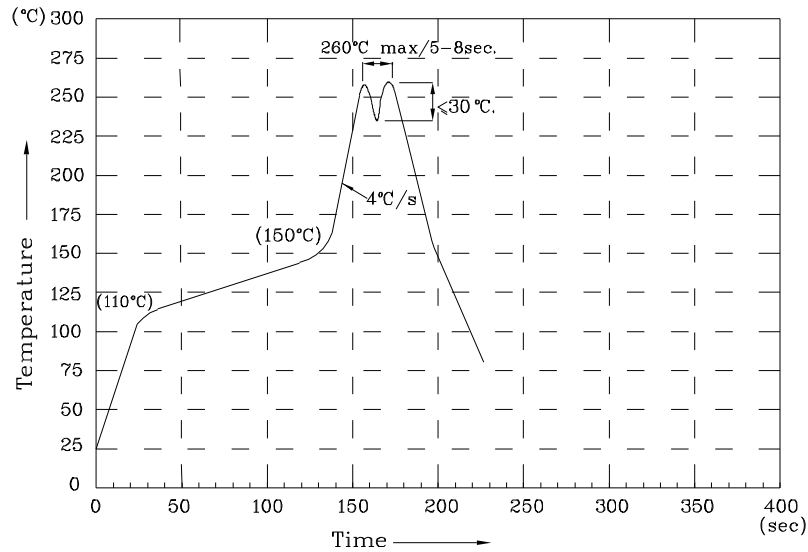

NOTES:

1. Recommend the wave temperature 245°C~260°C. The maximum soldering temperature should be less than 260°C.
2. Do not apply stress on epoxy resins when temperature is over 85 degree°C.
3. The soldering profile apply to the lead free soldering (Sn/Cu/Ag alloy).
4. No more than once.

Remarks:

If special sorting is required (e.g. binning based on forward voltage, Luminous intensity/ luminous flux, or wavelength), the typical accuracy of the sorting process is as follows:

1. Wavelength: +/-1nm
2. Luminous Intensity / Luminous Flux: +/-15%
3. Forward Voltage: +/-0.1V

Note: Accuracy may depend on the sorting parameters.



PACKING & LABEL SPECIFICATIONS

LMDKVG29M

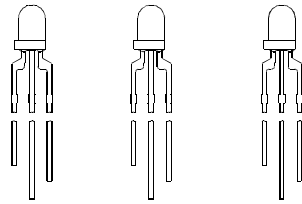

LABEL

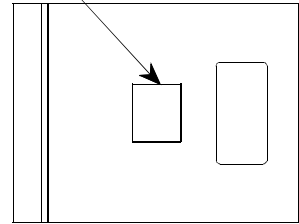

500PCS/BAG

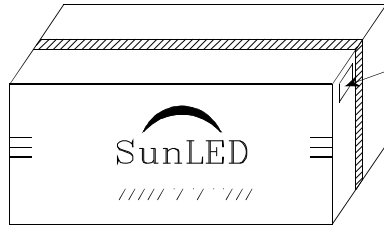

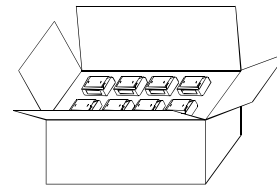

20K/BOX

OUTSIDE LABEL

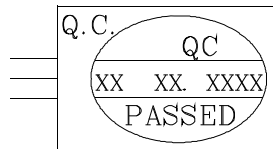

10K/BOX



| | |
|--|-----------|
| P/NO : Lxxx29x | |
| QTY : 500 pcs | CODE: XXX |
| S/N : XX | |
| LOT NO: | |
|  XXXXXXXXXXXXXXXXXXXXXXXXXXXX | |
| RoHS Compliant | |